

Art.-Number: 701723

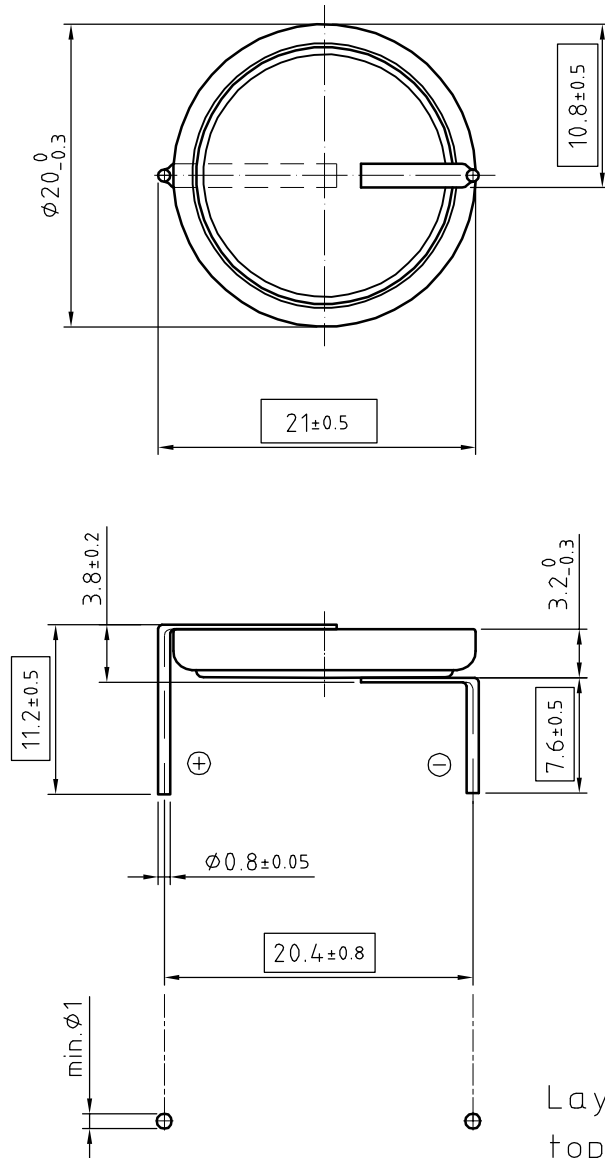

- Samples can deviate in the execution from the serie.

Tab material: CuNi44
All dimensions in mm.

- Dimensions and tolerances can be specified only after the testing of the devices for the mass production definitely

All framed values will be used for dimension checking !

The Products of Renata SA are neither designed nor authorized for use in certain areas of application of environment.
For further details we refer to our webpage www.renata.com/downloads/restriction_of_use

Rev.	①	01.11.14	PWU	Rev.	○			Customer's Approval		
Rev.	②	26.08.19	PWU	Rev.	○			Date		
Rev.	○			Rev.	○			Signature		
Title:							Scale	Drawn	24.11.06	SRI
CR2032 MFR AH1							2:1	Checked		
								Approved		

renata 
batteries

CH-4452 Itingen
Switzerland

3.9167.4-2